

RRIN12UEDC

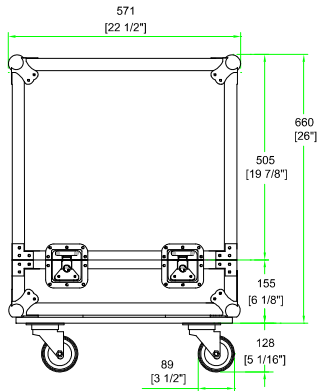

FRONT VIEW
BACK VIEW

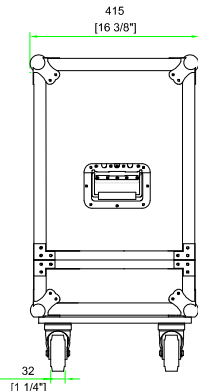

LEFT VIEW
RIGHT VIEW

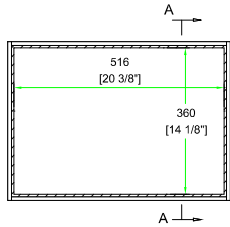

TOP VIEW OF COVER

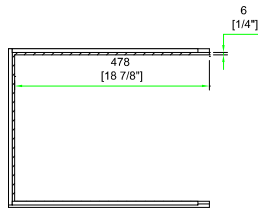

A-A VIEW

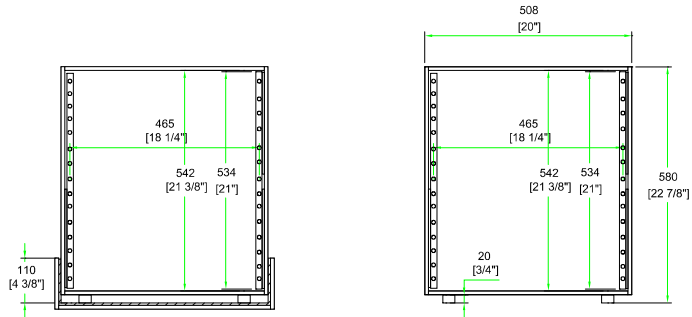
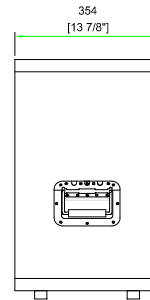

C-C VIEW

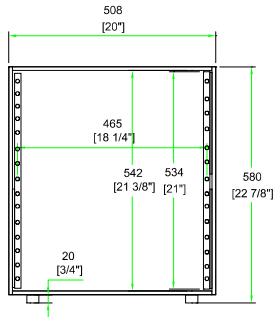

D-D VIEW

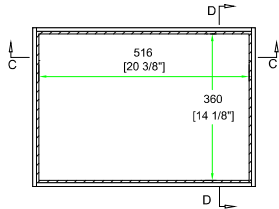
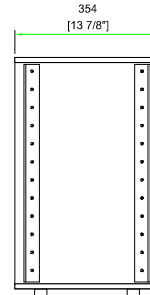

TOP VIEW OF BASE

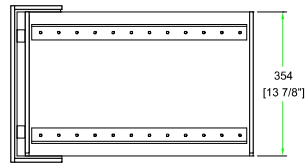

Signature of Approval

Printed Name
2007-10-12