

RR2MH250SC

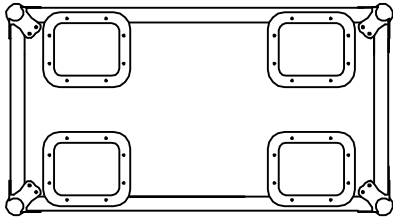

TOP VIEW

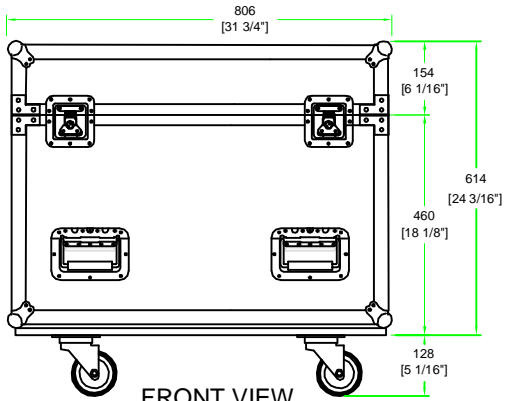

FRONT VIEW
BACK VIEW

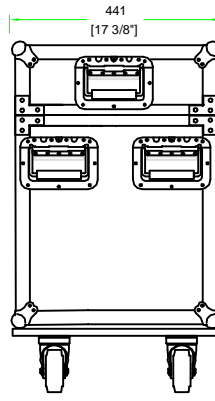

LEFT VIEW
RIGHT VIEW

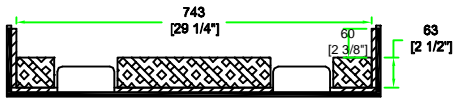

A-A VIEW

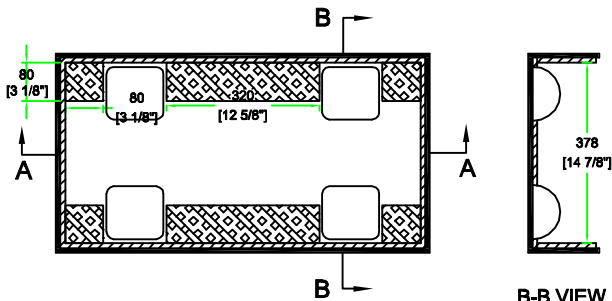

TOP VIEW OF COVER

B-B VIEW

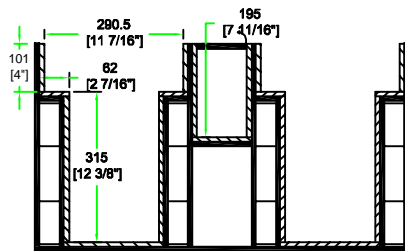

C-C VIEW

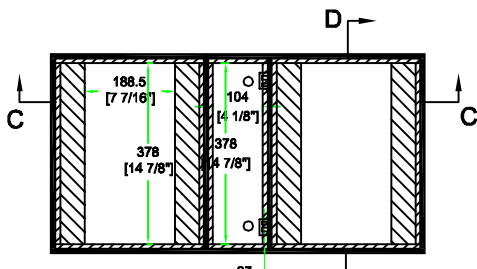

TOP VIEW OF BASE

D-D VIEW