



# RR10UEDHW

Because we know that lugging around your gear can be a real drag, we crafted the RR10UEDHW with our low profile wheels and pull-out handle so you can get a move on! Built smart with flexibility and comfort in mind, the RR10UEDHW accommodates professional effects units up to 10U. This rugged case is designed to fit all standard 19" rack-mountable equipment, features dual rack rails (mounted front and back at a 12 3/8" rack depth) and includes two removable covers for easy access to both sides of your rack. Built for the long haul!

## Rugged Road Ready Features

- \* Beefy, Stackable Ball Corners
- \* Double Anchor Industrial Rivets
- \* Recessed, Industrial Grade Latches
- \* Recessed, Spring Loaded Handles
- \* Industrial Grade Rubber Feet
- \* Premium 3/8" Vinyl Laminated Plywood
- \* Tongue and Groove Locking Fit
- \* Low Profile Wheels and Pull Out Handle
- \* Heavy Duty Rack Rails
- \* Mounting Hardware Included
- \* ATA 300 Rating
- \* Road Ready Limited Lifetime Warranty

## IO Deluxe Effect Rack Case W/ Pull-Out Handle & Wheels

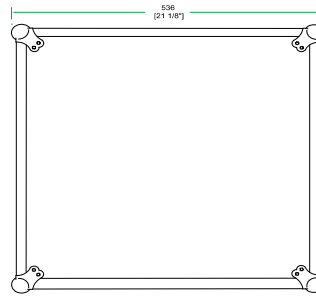

FRONT VIEW

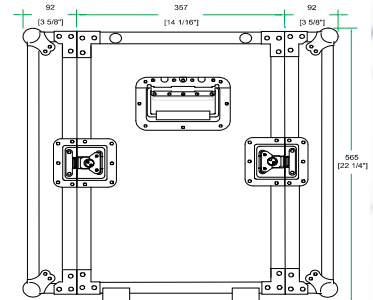

LEFT VIEW

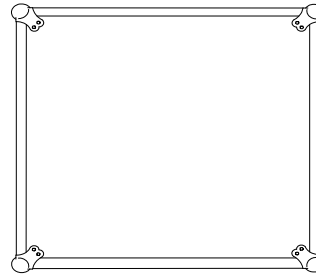

BACK VIEW

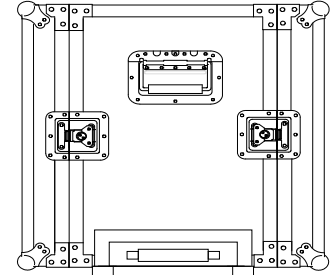

RIGHT VIEW

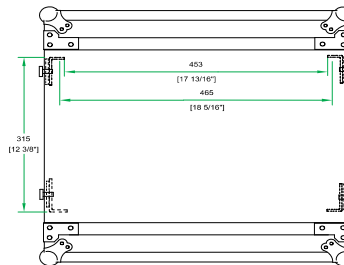

TOP VIEW

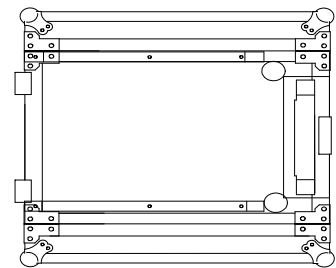

BOTTOM VIEW

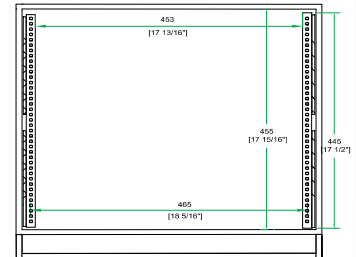

INSIDE VIEW

[www.roadreadycases.com](http://www.roadreadycases.com)