

RRS408

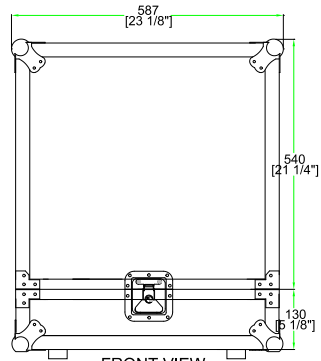

FRONT VIEW
BACK VIEW

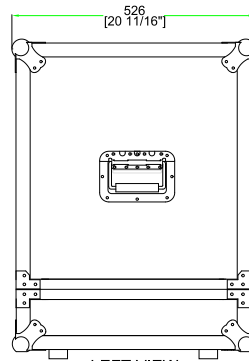

LEFT VIEW
RIGHT VIEW

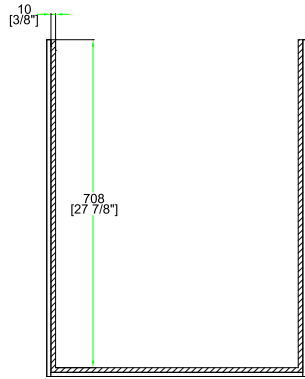

A-A VIEW

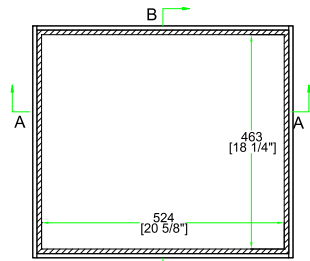

TOP VIEW OF COVER

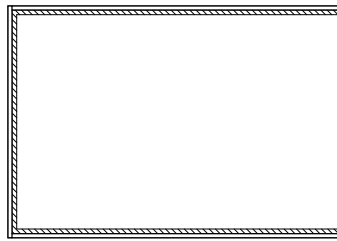

B-B VIEW

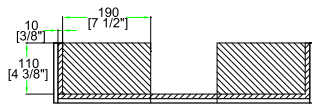

C-C VIEW

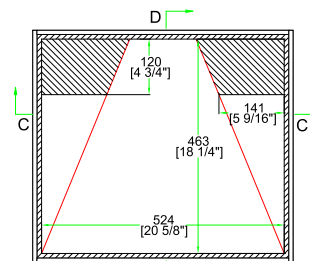

TOP VIEW OF BASE

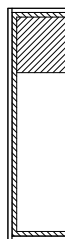

D-D VIEW

Signature of Approval

Printed Name: 2008-03-17